

FlexxPump4 B412A

Technical data sheet (Item number 210720)

Product Description

The FlexxPump4 B412A (FP4 B412A) is a highly efficient, microprocessor-controlled multi-point-lubricator designed for a need-based direct supply of lubrication points with grease or highly viscous.

Various operating modes are available. In the hour mode (-h-), pause times as well as a number of dispensing strokes can be set. In the emptying time mode (Et), an emptying time of the cartridge can be set in months.

The display of the FP4 B412A enables crucial status monitoring such as level pre-warning, empty level, proper running, back pressure of the lubrication point and error messages.

The pump control detects the empty level of the cartridge.

The FP4 B412A is powered by an internal battery pack. There are lithium and alkaline battery packs to choose from. At low temperatures (e.g., outdoors) the use of lithium battery packs is recommended.

Thanks to battery packs, the FP4 B412A can be used in many areas flexibly where external power is not available.

Pre-filled lubricant cartridges and battery packs as well as other accessories are available.

Intended Use

Intended use of the FP4 B412A is to supply two lubrication points with grease or highly viscous.

Technical Data

Power supply		+ 6 VDC
Number of outlets		2
Operating temperature	min.	- 20 °C
	max.	+ 60 °C
Maximum output pressure		70 bar
Protection class		IP 54
Volume per dispensing stroke		0,15 ml
Lubricants	Grease	up to NLGI Class 2
	Oil	up to 30.000 mm ² /s (40 °C)
Cartridge volume		400 ml
Outlet connection		Connector for hose 6 mm
Mounting position		any
Weight (without cartridge)		1050 g

Important instructions

To ensure trouble-free operation on the FP4 B412A, do not disassemble the unit. To prevent damage to the electronics, only original battery packs must be used.

A detailed description of the operation and control of the FP4 B412A is available in the up-to-date user manual!



Figure 1: FP4 B412A front view



Figure 2: FP4 B412A with 400 ml

Operating mode Hour mode (-h-)

The hour mode -h- allows setting the number of dispensing strokes (c) and a pause time (h) between two dispensing cycles in hours. Pause times (h) between 1...240 hour(s) and the number of dispensing strokes (c) between 1...30 can be set. Therefore, a dispensing cycle consists of up to 30 dispensing strokes. The FP4 B412A delivers the set number of dispensing strokes after the pause time has elapsed.

Operating mode Emptying time (Et)

The emptying time mode Et allows the emptying time of the cartridge to be set in months. Emptying times between 1...36 month(s) can be set. The FP4 B412A calculates a pause time and delivers a dispensing stroke after the pause time has elapsed.

Default settings Hour mode (-h-)



Pause time: h = 3 hours

Number of strokes: c = 1

Default settings Emptying time (Et)

Emptying time: Et = 6 months

Display – Meaning of LEDs

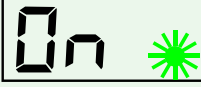
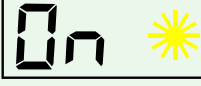
LCD	Explanation
	The red LED flashes every 5 seconds if there is an error.
	The yellow LED lights up when the action area has been touched with the magnetic pen (magnetic pen detected).
	The green LED lights up for approx. 10 ... 18 seconds during a dispensing process.
	The green LED flashes every 60 seconds if the FP4 B412A is switched on (ON) and there is no error.
	The yellow LED flashes every 60 seconds, when the pre-warning limit of the cartridge is reached.

Error messages on the display

Error messages	Meaning
E1	Error E1 (empty cartridge)
E2	Error E2 (overload)
E3	Error E3 (undervoltage)
E4	Error E4 (internal device error)

Commands for control

The commands explained below can be called up at any time in operating mode -h- and in operating mode Et.

Command	Explanation
INF	The INF command provides an informative overview of the current settings on the FP4 B412A.
SET	The SET command allows you to make changes to the operating mode.
RUN	The RUN command enables a single dispensing to be triggered manually on the FP4 B412A.
PRO	The PRO command allows you to make changes to the settings and dispensing action of the FP4 B412A.
FIL	The FIL command allows you to manually trigger 40 dispensing action of the FP4 B412A.

Installation dimensions

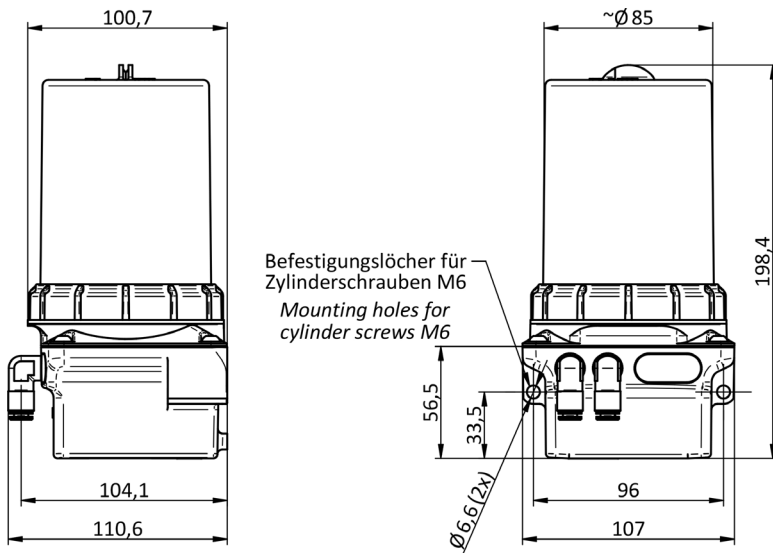

Installation

When installing, allow a minimum of 370 mm clearance from the top of the pump in opening direction of the cartridge for easy replacement.

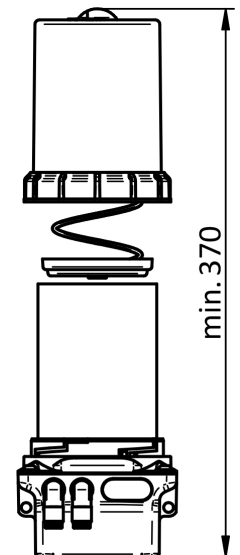

Materials

Housing of drive unit	Die-cast zinc, powder-coated
Transparent top	Polyamide (impact-resistant, lubricant-resistant, UV-stable)
Drive unit cover	Polyamide 6.6, glass fiber reinforced
Screws	Stainless steel A2
Hose connector	Brass, nickel-plated
Grease cartridge	Polypropylene, polyethylene
Compression plate	Polyamide 6.6 (impact-resistant, lubricant-resistant)
Compression spring	Stainless spring steel

Similar products

Description	Difference	Item-Nr.
FlexxPump4 B412	Drive unit cover green	210718
FlexxPump4 B412-M12	Connector for LED cable, green drive unit cover	210722
FlexxPump4 B412A-M12	Connector for LED cable, anthracite drive unit cover	210724
FlexxPump4 B212	Cartridge 250 ml, green	210726
FlexxPump4 B212A	Cartridge 250 ml, anthracite	210728

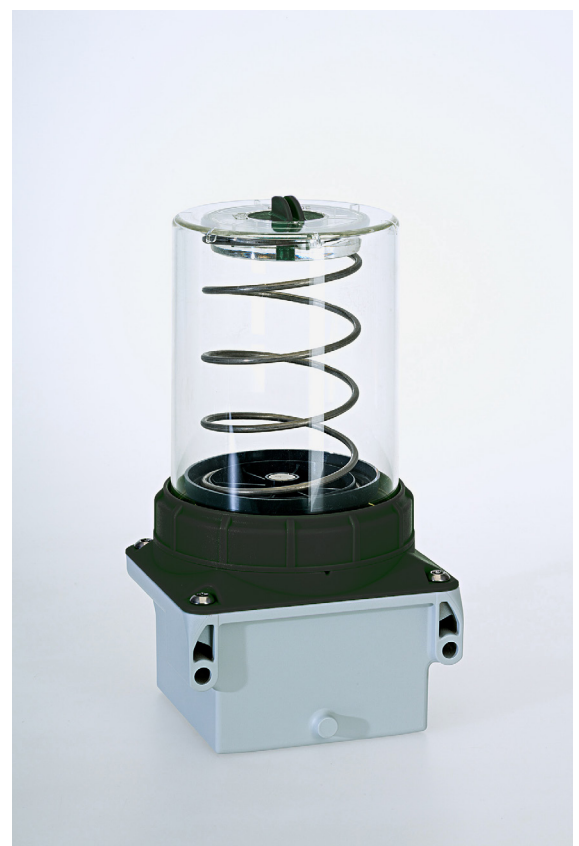

Figure 3: FP4 B412A back

Please visit www.triboserv.com for available Accessories

The above data and information correspond to the current state of our knowledge and development. However, they do not represent an assurance of properties or a guarantee for the suitability of the products in individual cases. We reserve the right to change the information in this technical data sheet or to make technical changes at any time and without prior notice. The representation on the pictures may differ from the original.

TriboServ

SpectroLube Inc.
President: Aykut Ozdemir

2212 Silverbirch Court
L7M 3H4 Burlington, Ontario
Canada

Phone: +1 (647) 278-4366
Mail: aykut.ozdemir@spectrolube.com
Web: www.spectrolube.com



Quality Management

We are certified.

ISO 9001:2015

© – 2021

EN
Version: 1.0
Page 3 of 3

FlexxPump4 B412A – Main dimensions & Installation